

WAT-910HX MBD (G3.7) 1/3" Super High Sensitivity Miniature Board Camera

Ultra-compact design only 23 x 23mm for limited space and embedded application

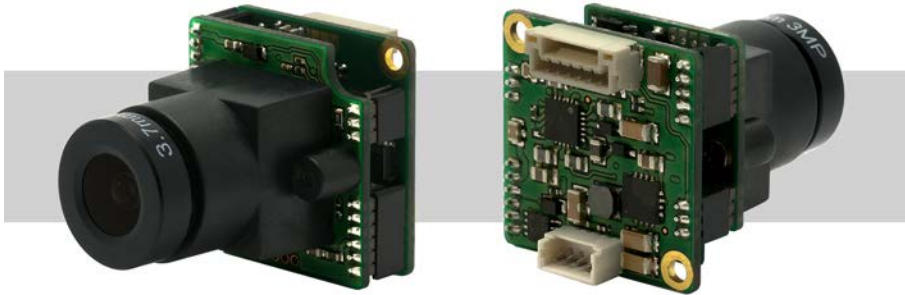

Key features

- Min. illumination 0.00009 lx F1.8 (AGC ON=48dB, Shutter=x8)
- Advanced setting available by OSD (On Screen Display) through an optional remote control
- Build-in M12 lens G3.7 (f=3.7mm F1.8), Various Optional M12 lenses available
 ※Glass lenses and pinhole lens are not interchangeable

Dimensions

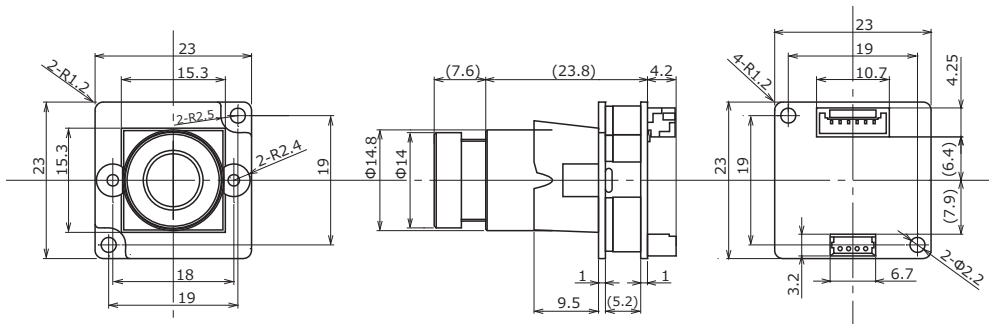











Specifications

Video standard		EIA	CCIR
Pick-up element		1/3 inch interline transfer CCD image sensor	
Number of effective pixels		768(H) × 494(V)	752(H) × 582(V)
Unit cell size		6.4µm(H) × 7.5µm(V)	6.5µm(H) × 6.3µm(V)
Synchronizing system		Internal	
Scanning system		2:1 interlace	
Video output		Composite video, 1.0 V(p-p) 75Ω (Unbalanced)	
Resolution (H)		More than 570TVL (Center)	
Minimum illumination		0.00009 lx F1.8 (AGC ON=48dB, Shutter=x8)	
S/N		More than 50dB (AGC OFF=6dB, γ=0.45, Shutter=OFF, NR=ON)	
Function settings		OSD : Remote controller	
AE mode	Fixed	x2, x4, x8, x16, x32, x64, x128, x256 (field)	
		1/60, 1/120 sec.	1/50, 1/100 sec.
	1/250, 1/500, 1/1000, 1/2000, 1/4000, 1/10000 sec.		
EI	1/60 - 1/100000 sec.		1/50 - 1/100000 sec.
	x8 - 1/100000 sec.		
AGC	ON	0 - 48dB (Max. 6 - 48)	
	OFF	-	
MGC		0 - 48dB (6dB step)	
Gamma characteristics		γ=0.45	
Video level		Adjustable	
Noise reduction		3D+2DNR ON Level adjustable	
Wide dynamic range		D-WDR OFF/ON Level adjustable	
Lens iris		-	
Back light compensation		BLC, HSBLC	
White blemish correction		Up to 64 pixels	
Sharpness		Level adjustable	
Defog		OFF/ON Level adjustable	
Digital zoom		ZOOM (x1 - x256), PAN/TILT	
Privacy mask		15 masks	
Mirror image		OFF, V-FLIP, H-FLIP, HV-FLIP	
Freeze		-	
Motion detection		OFF/ON Select from 96 detection areas	
Neg.image		-	
Interface		4P connector (Composite Video, Power in), Remote control (RC-01)	
Power supply		DC+12V±10%	
Power consumption		0.96W (80mA)	
Operating temperature		-10 - +50°C	
Storage temperature		-30 - +70°C	
Operating / Storage humidity		95% RH or less (Without condensation)	
Lens mount		M12 P=0.5	
Standard lens		M3718BC-12 (f3.7 F1.8)	
Weight		Approx. 14g	
Accessories		4P cable	

Accessories
 Options

WAT-910HX MBD (G3.7)

- Miniature lenses**
-  2520BC-12
 -  2920BC-12
 -  M3718BC-12 (Standard)
 -  0625BC-12
 -  0820BC-12
 -  1220BC-12
 -  M1616BC-12
 -  2540EX014-M12

- Extenders**
-  EX005-M12-2
 -  EX010-M12-2

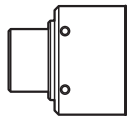
- Camera housing**
-  CH-01

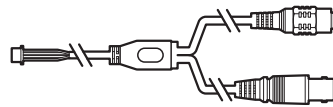
- Cable with connectors**
-  CB-01

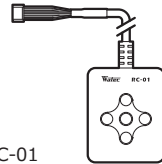
- Remote control**
-  RC-01

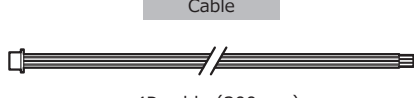
- Cable**
-  4P cable (300mm)

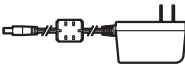
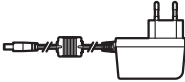
- Power supply adaptors**
-  SWI12-12-N-P5
 -  SWI12-12-E-P5

